



POWERED BY HYDRAULICS



**KW Hydraulik**

Aggregate und Werkzeuge

[www.dynaset-hydraulik.de](http://www.dynaset-hydraulik.de) [info@kw-hydraulik.de](mailto:info@kw-hydraulik.de) +49 3675 421 980

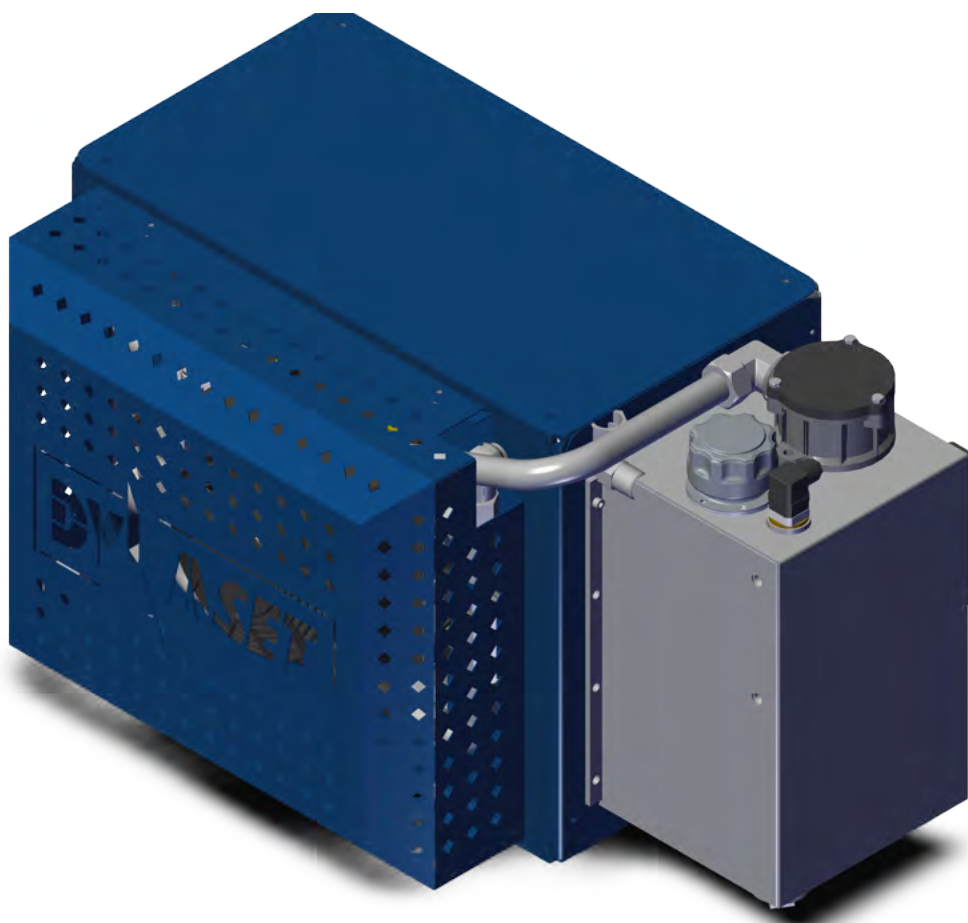

## DATA SHEET

### HGV POWER BOX HYDRAULIC GENERATOR SYSTEM



HGV Power Box 3,5 S  
HGV Power Box 6,5 S  
HGV Power Box 10 S

### DIMENSIONS

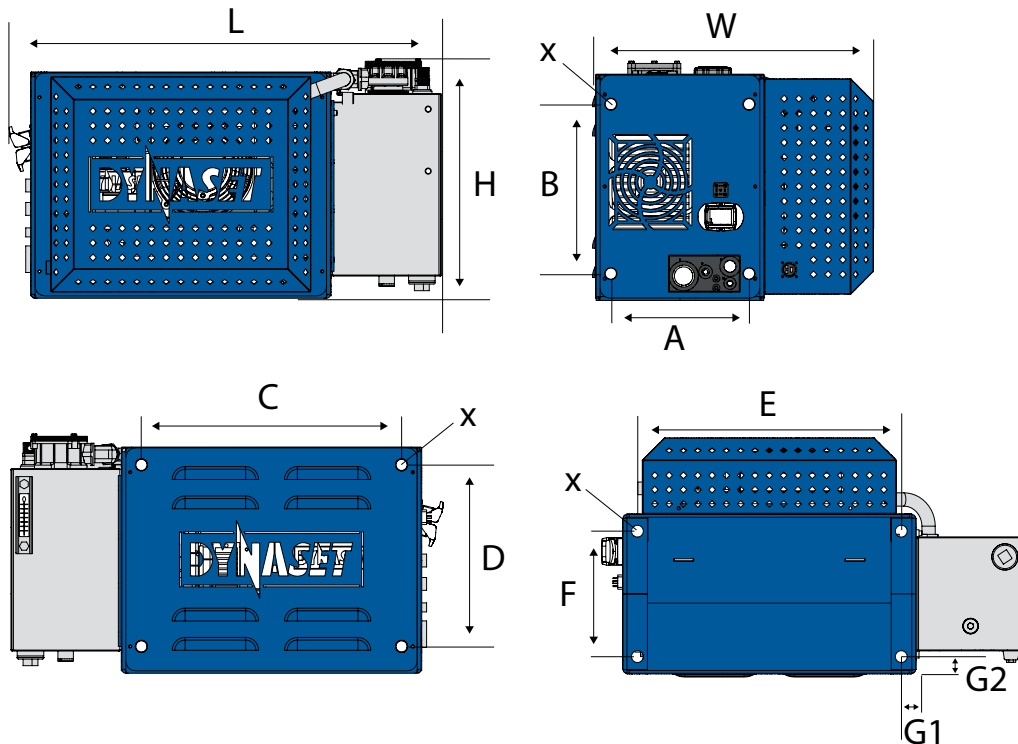

MODEL	DIMENSIONS, mm (in)											
	L	W	H	A	B	C	D	E	F	G1	G2	X
S - Model	884 (34.8)	502 (19.8)	490 (19.3)	263 (10.3)	347 (13.7)	535 (21)	372 (14.6)	553 (21.8)	263 (10.3)	31 (1.2)	36 (1.4)	25 (1)

### CONNECTIONS

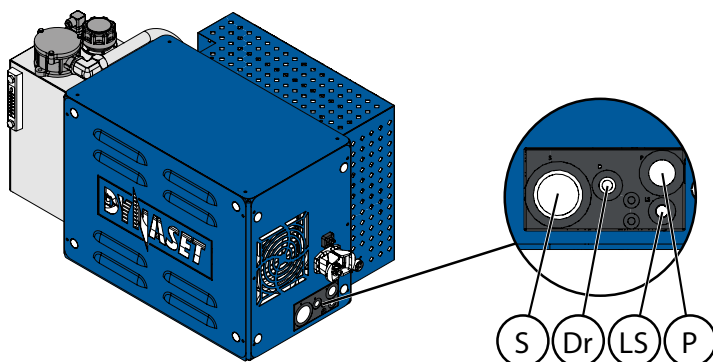

MODEL	P	S	Dr	LS
S - Model	3/4"	1 1/2"	3/8"	1/4"

### TECHNICAL SPECIFICATIONS

		HGV Power Box 3,5	HGV Power Box 6,5	HGV Power Box 10
<b>OUTPUT CHARACTERISTICS</b>				
Output Power max.	kVA	3,5	6,5	10
Power factor	kW / cos φ	3,5 / 1,0	6,5 / 0,8	10 / 0,8
Output Voltage	1 phase	230 VAC	230 VAC	230 VAC
	3 phase	-	400 VAC	400 VAC
Nominal Current	1 phase	15,2	17	26,1
	3 phase	-	9,4	14,4
Sockets (1 phase / 3 phase / cable K)		2 / - / -	2 / 1 / K	2 / 1 / K
Pump speed	rpm	500 - 4000	750 - 4000	850 - 4000

High speed pump (up to 5000 rpm) model also available.  
Other Power box models also available by request.



Menotie 3  
FI-33470 Ylöjärvi, Finland  
tel: +358 3 3488 200  
info@dynaset.com



#### ELECTRICITY

HG Hydraulic Generator  
HGV POWER BOX Variable Hydraulic Generator System  
HGV Variable Hydraulic Generator System  
HWG Hydraulic Welding Generator  
HGG Hydraulic Ground Power Generator



#### HIGH PRESSURE WATER

HPW Hydraulic High Pressure Water Pump  
HPW Hydraulic Power Washer  
KPL High Pressure Street Washing Unit  
HPW-DUST High Pressure Dust Suppression System  
PPL High Pressure Pipe Cleaning Unit  
HPW-FIRE High Pressure Firefighting System  
FP Fire Fighting Piercing Kit  
HDF Hydraulic Drilling Fluid Pump  
JPL High Pressure Bin Washing System  
HSP Hydraulic Submersible Pump



#### COMPRESSED AIR

HK Hydraulic Piston Compressor  
HKL Hydraulic Rotary Vane Compressor  
HKR Hydraulic Screw Compressor



#### MAGNET POWER

HMG PRO Hydraulic Magnet Generator  
MAG Lift Magnet  
HMAG PRO Hydraulic Magnet



#### VIBRATION

HVB Hydraulic Vibra  
HVD Hydraulic Directional Vibra  
HRC Hydraulic Reversal Cylinder



#### POWER BOOSTING

HPI Hydraulic Pressure Intensifier  
HPI-C Hydraulic Pressure Intensifier for Cylinder



#### KNOW-HOW

Hydraulic Power Take-off (PTO)  
Hydraulic Power Unit Technology  
De-Icing Technology  
Installation Valves  
HHK Hydraulic Grinder  
HV/HVY Hydraulic Winch / Winch Unit

[www.dynaset.com](http://www.dynaset.com)

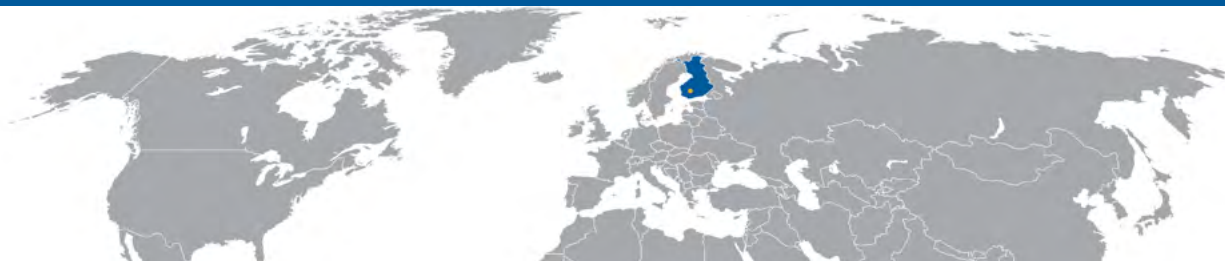

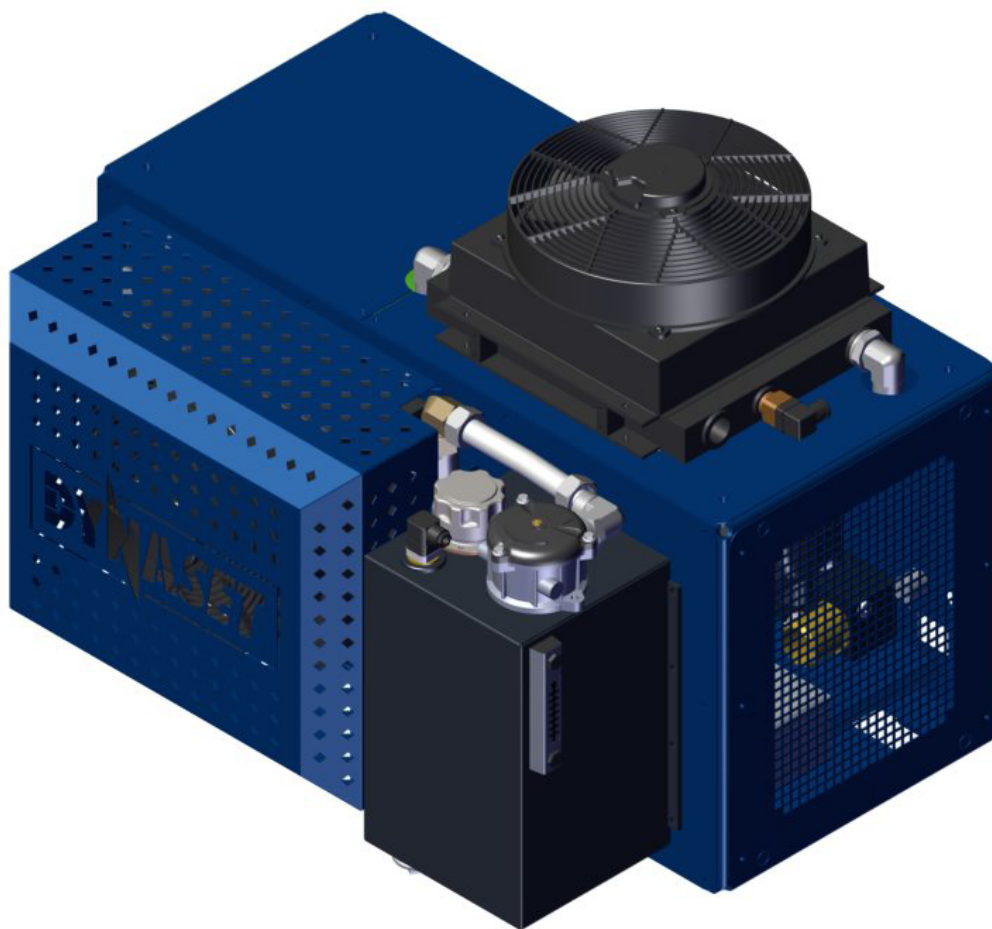

08/19  
rev 1.1

## DATA SHEET

### HGV POWER BOX HYDRAULIC GENERATOR SYSTEM



HGV Power Box 15 M  
HGV Power Box 20 M

### DIMENSIONS

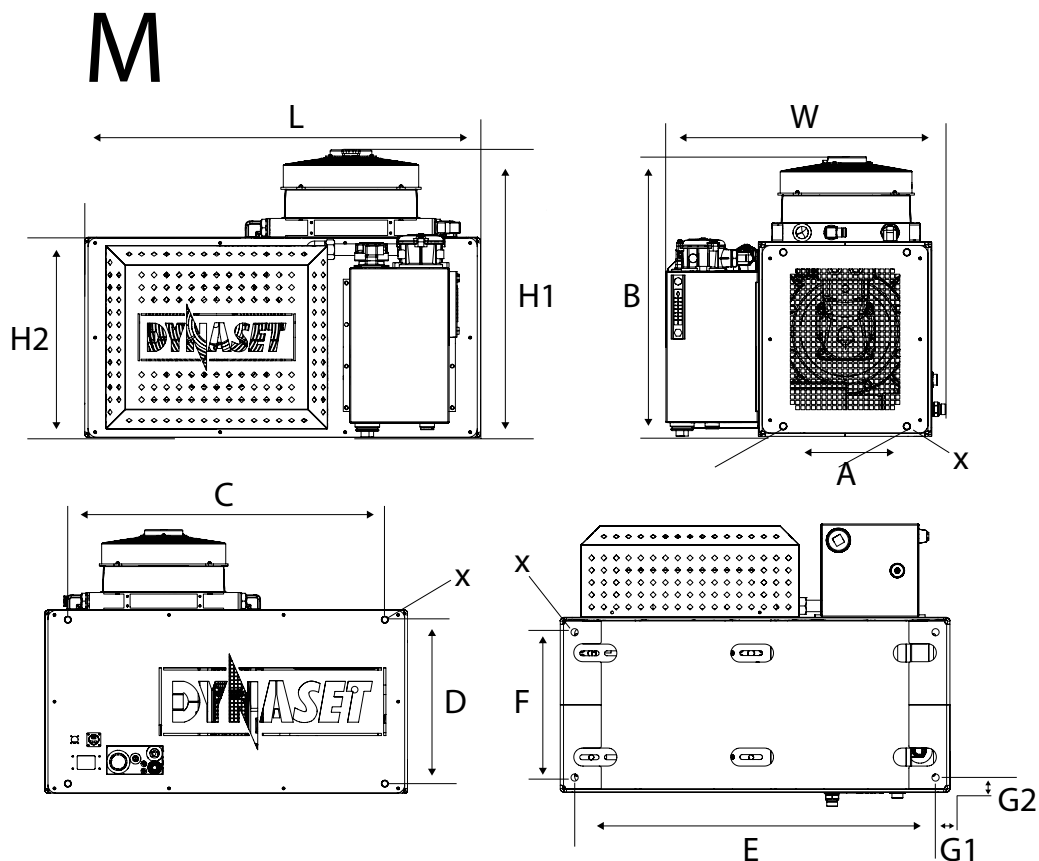

MODEL	DIMENSIONS, mm (in)											
	L	W	H1	H2	A	B	C	D	E	F	G1/G2	X
M- model	953 (37.6)	656 (25.9)	707 (27.9)	482 (19.0)	305 (12)	430 (16.9)	830 (32.7)	430 (16.9)	880 (34.6)	335 (13.2)	36,5 (1.4)	25 (1)

### CONNECTIONS

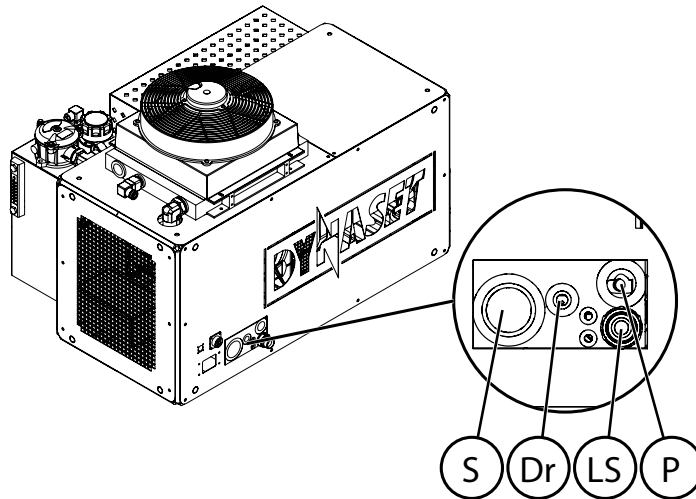

MODEL	P	S	Dr	LS
M- model	3/4"	1 1/2"	3/8"	1/4"

### TECHNICAL SPECIFICATIONS

		HGV Power Box 15	HGV Power Box 20
<b>OUTPUT CHARACTERISTICS</b>			
Output Power max.	kVA	15	20
Power factor	kW / cos φ	15 / 0,8	20 / 0,8
Output Voltage	1 phase	230 VAC	230 VAC
	3 phase	400 VAC	400 VAC
Nominal Current	1 phase	39,1	52,2
	3 phase	21,7	28,9
Sockets (1 phase / 3 phase / cable K)		2 / 1 / -	2 / 1 / -
Pump speed	rpm	700 - 3000	650 - 3000

High speed pump (up to 5000 rpm) model also available.  
Other Power box models also available by request.



Menotie 3  
FI-33470 Ylöjärvi, Finland  
tel: +358 3 3488 200  
info@dynaset.com



#### ELECTRICITY

HG Hydraulic Generator  
HGV POWER BOX Variable Hydraulic Generator System  
HGV Variable Hydraulic Generator System  
HWG Hydraulic Welding Generator  
HGG Hydraulic Ground Power Generator



#### HIGH PRESSURE WATER

HPW Hydraulic High Pressure Water Pump  
HPW Hydraulic Power Washer  
KPL High Pressure Street Washing Unit  
HPW-DUST High Pressure Dust Suppression System  
PPL High Pressure Pipe Cleaning Unit  
HPW-FIRE High Pressure Firefighting System  
FP Fire Fighting Piercing Kit  
HDF Hydraulic Drilling Fluid Pump  
JPL High Pressure Bin Washing System  
HSP Hydraulic Submersible Pump



#### COMPRESSED AIR

HK Hydraulic Piston Compressor  
HKL Hydraulic Rotary Vane Compressor  
HKR Hydraulic Screw Compressor



#### MAGNET POWER

HMG PRO Hydraulic Magnet Generator  
MAG Lift Magnet  
HMAG PRO Hydraulic Magnet



#### VIBRATION

HVB Hydraulic Vibra  
HVD Hydraulic Directional Vibra  
HRC Hydraulic Reversal Cylinder



#### POWER BOOSTING

HPI Hydraulic Pressure Intensifier  
HPI-C Hydraulic Pressure Intensifier for Cylinder



#### KNOW-HOW

Hydraulic Power Take-off (PTO)  
Hydraulic Power Unit Technology  
De-Icing Technology  
Installation Valves  
HHK Hydraulic Grinder  
HV/HVY Hydraulic Winch / Winch Unit

[www.dynaset.com](http://www.dynaset.com)

